

Varenummer: 2303039131  
Beskrivelse: E+G Fast Spændegreb  
MF.63 N-8

## Mål

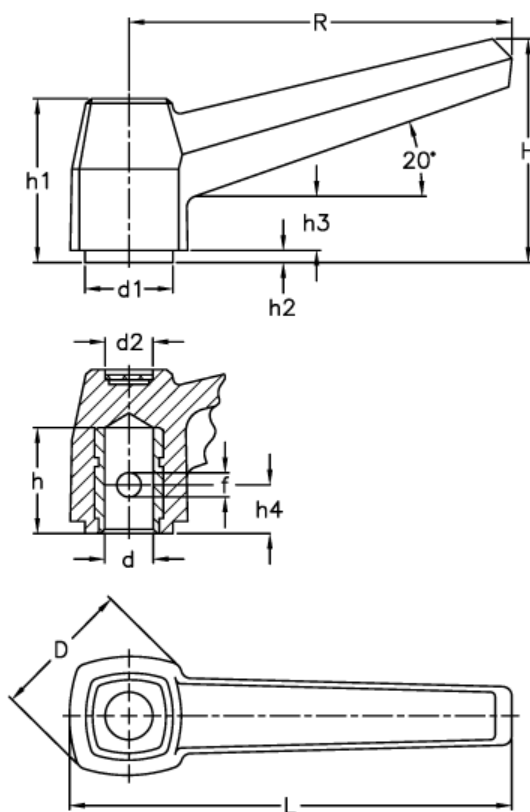

D	= 23	h2	= 2.0
d1	= 14.5	h3	= 11
d2	= 9	h4	= 8
d H9	= 8	L	= 73
f	= 4	R	= 63
h	= 20		
H	= 37		
h1	= 27		